

# SAGINAW CONTROL & ENGINEERING

## SCE-72EL3018SSFS

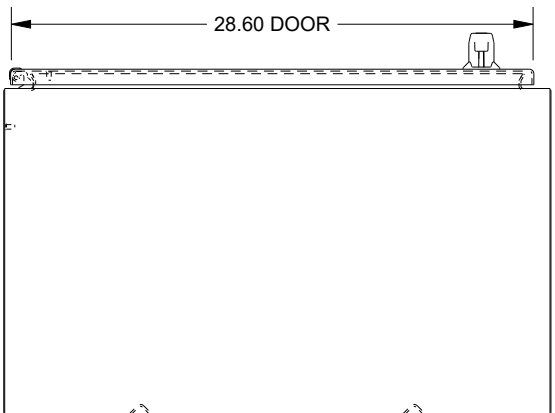

BOTTOM VIEW

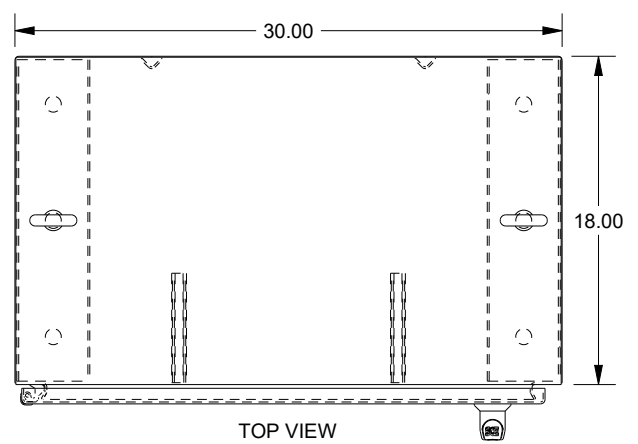

TOP VIEW

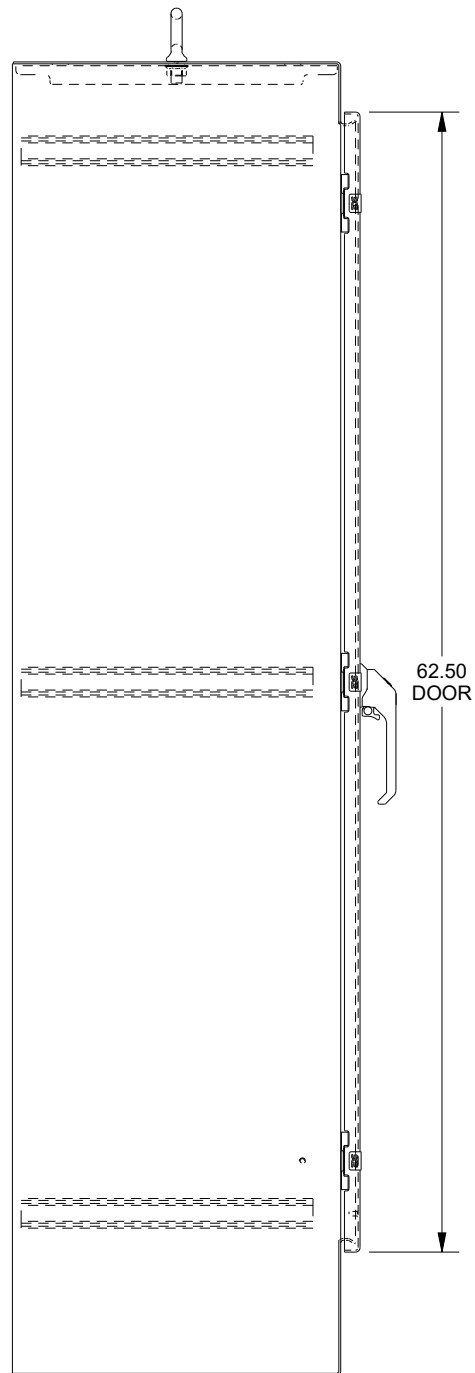

LEFT SIDE VIEW

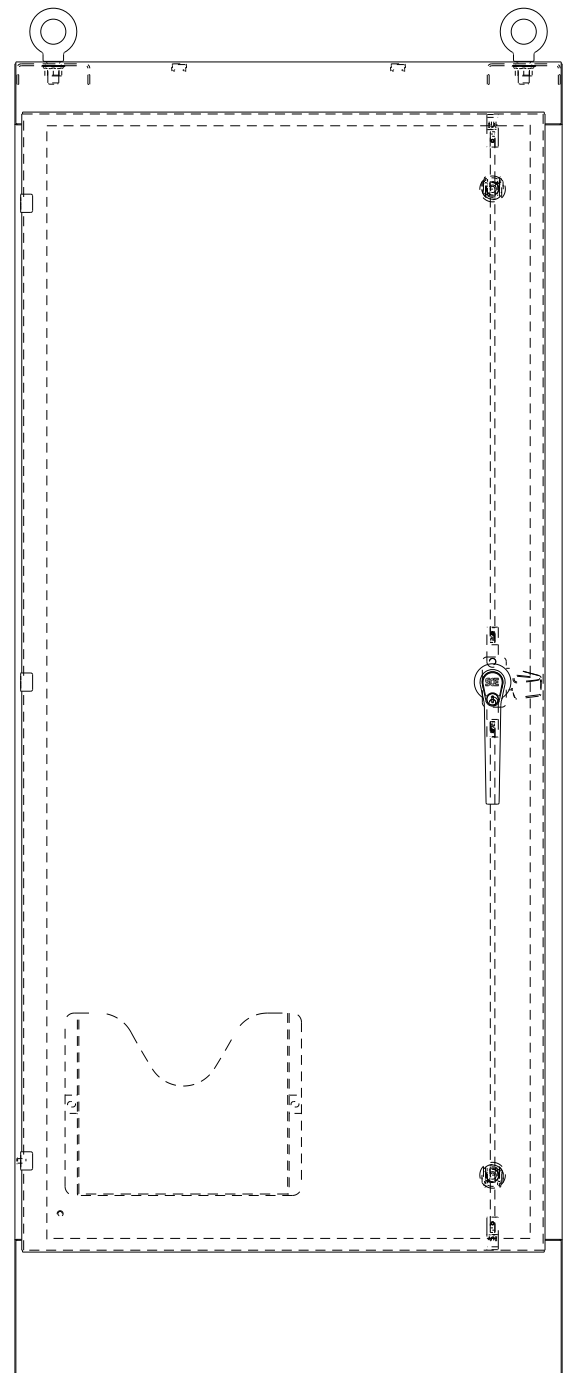

FRONT VIEW

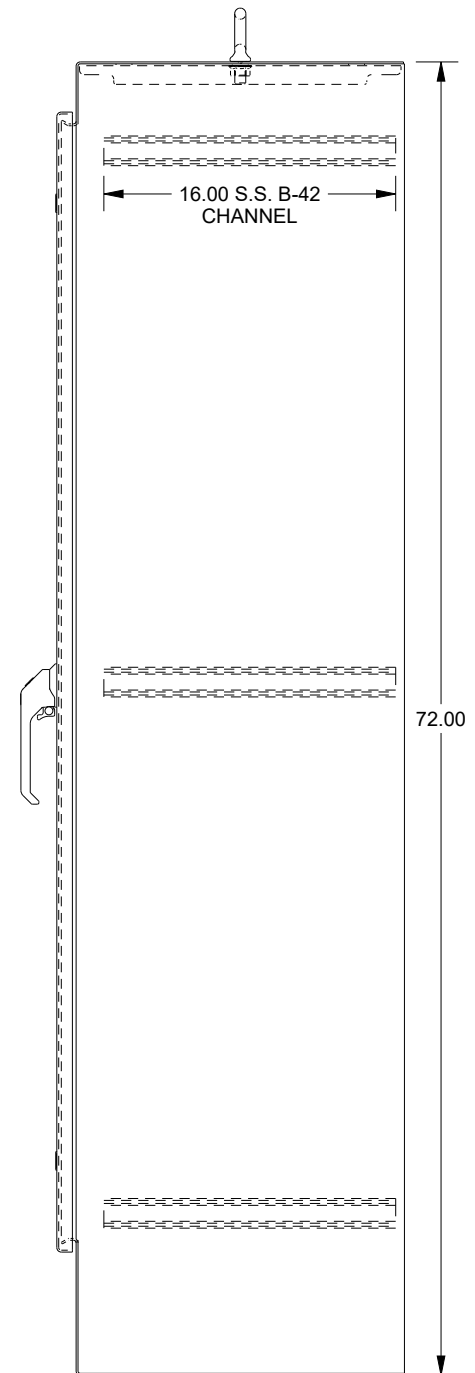

RIGHT SIDE VIEW

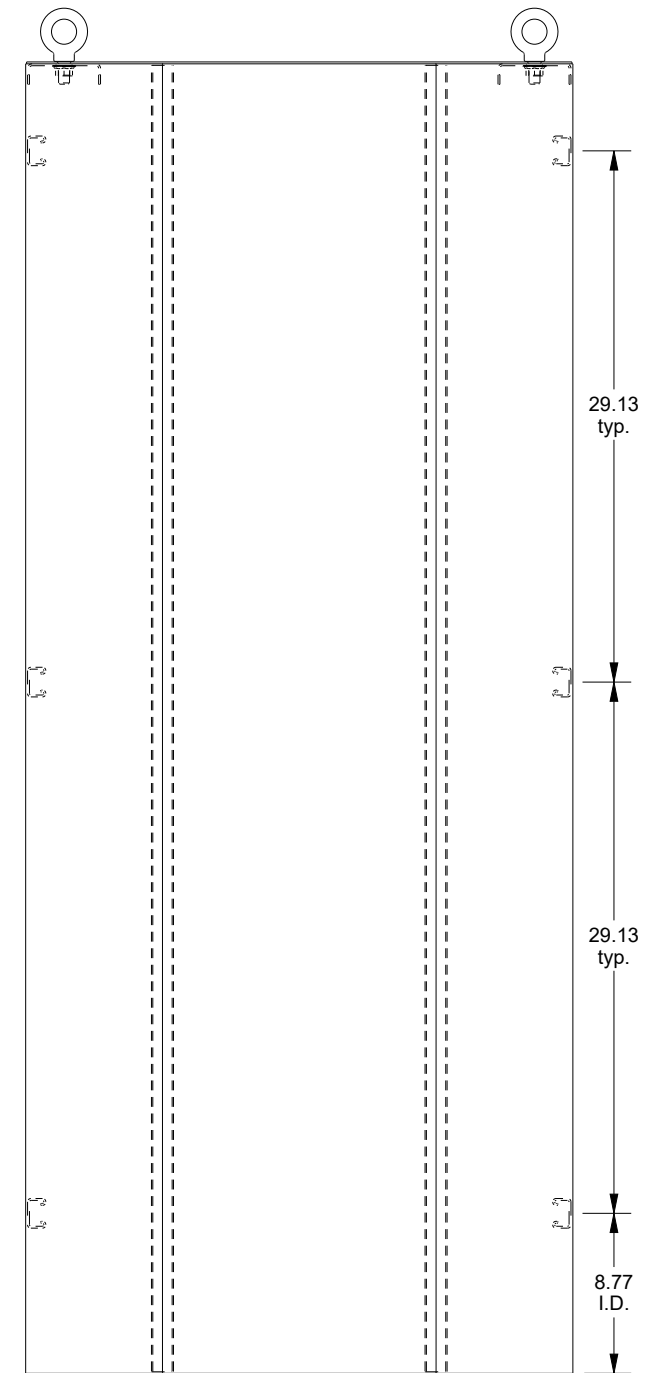

EXTERNAL REAR VIEW